

SK520XDLC-10		ME Boom: 6.5 m ME Arm: 2.6 m Bucket: without Counterweight: 11,200 kg Shoe: HD 800 mm												
		3.0 m		4.5 m		6.0 m		7.5 m		9.0 m		At Max. Reach		Radius
A		3.0 m	4.5 m	6.0 m	6.0 m	7.5 m	7.5 m	9.0 m	9.0 m	At Max. Reach	At Max. Reach			
B		3.0 m	4.5 m	6.0 m	6.0 m	7.5 m	7.5 m	9.0 m	9.0 m	At Max. Reach	At Max. Reach			
9.0m	kg											*11,200	*11,200	6.24m
7.5m	kg							*11,040	*11,040			*9,740	*9,740	7.56m
6.0m	kg					*11,890	*11,890	*10,860	*10,860			*9,060	*9,060	8.41m
4.5m	kg					*13,460	*13,460	*11,510	*11,510			*8,790	*8,790	8.93m
3.0m	kg					*15,240	*15,240	*12,390	11,350	*10,930	8,740	*8,810	8,500	9.17m
1.5m	kg					*16,600	14,840	*13,150	10,970	*11,160	8,580	*9,110	8,390	9.15m
G.L.	kg					*17,150	14,520	*13,510	10,760			*9,760	8,680	8.88m
-1.5m	kg			*22,070	*22,070	*16,770	14,480	*13,140	10,750			*10,940	9,490	8.34m
-3.0m	kg	*25,340	*25,340	*19,650	*19,650	*15,150	14,730					*10,990	*10,990	7.45m
-4.5m	kg			*14,980	*14,980							*9,830	*9,830	6.06m

- Notes:**
- Do not attempt to lift or hold any load that is greater than these lift capacities at their specified lift point radius and heights. Weight of all accessories must be deducted from the above lift capacities.
 - Lift capacities are based on machine standing on level, firm, and uniform ground. User must make allowance for job conditions such as soft or uneven ground, out of level conditions, side loads, sudden stopping of loads, hazardous conditions, experience of personnel, etc.
 - Arm top defined as lift point.
 - The above lifting capacities are in compliance with ISO 10567. They do not exceed 87% of hydraulic lifting capacity or 75% of tipping load. Lifting capacities marked with an asterisk (*) are limited by hydraulic capacity rather than tipping load.
 - Operator should be fully acquainted with the Operator's and Maintenance Instructions before operating this machine. Rules for safe operation of equipment should be adhered to at all times.
 - Lift capacities apply to only machine as originally manufactured and normally equipped by KOBELCO CONSTRUCTION MACHINERY CO., LTD.

STANDARD EQUIPMENT

ENGINE

- Engine, HINO P11C, diesel engine with turbocharger and intercooler
- Automatic engine deceleration
- Auto Idle Stop (AIS)
- Batteries (2 x 12V - 112Ah)
- Starting motor (24V - 6kW), 60 amp alternator
- Automatic engine shut-down for low engine oil pressure
- Engine oil pan drain cock
- Double element air cleaner

CONTROL

- Working mode selector (H-mode, S-mode and ECO-mode)
- Power Boost

SWING SYSTEM & TRAVEL SYSTEM

- Swing rebound prevention system
- Two-speed travel with automatic shift down
- Sealed & lubricated track links
- Grease-type track adjusters
- 800mm HD triple grouser shoe
- Automatic swing brake
- Tow eyes

HYDRAULIC

- Boom regeneration system
- Auto warm up system
- Aluminum hydraulic oil cooler
- Arm interflow system
- Hydraulic fluid filter clog detector

MIRRORS & LIGHTS

- Two rear view mirrors
- Five front working lights (Two for boom, one for boom cylinder, one for right storage box and one for cab)

CAB & CONTROL

- Two control levers, pilot-operated
- Horn, electric
- Cab light (interior)
- Luggage tray
- Large cup holder
- Detachable two-piece floor mat
- Headrest
- Handrails
- Intermittent windshield wiper with double-spray washer
- Tinted safety glass
- Pull-up type front window and removable lower front window
- Easy-to-read multi-display color monitor
- Automatic air conditioner
- Emergency escape hammer
- KOMEXS
- Suspension seat
- 24V outlet

OPTIONAL EQUIPMENT

- N&B Piping
- Refilling pump
- Rear view camera
- 600mm HD triple grouser shoe
- ROPS cab
- Two cab lights
- Travel alarm
- Additional track guide
- Step for 800mm shoes

Note: Standard and optional equipment may vary. Consult your KOBELCO dealer for specifics.

Note: This catalog may contain attachments and optional equipment that are not available in your area. And it may contain photographs of machines with specifications that differ from those of machines sold in your areas. Please consult your nearest KOBELCO distributor for those items you require. Due to our policy of continuous product improvements all designs and specifications are subject to change without advance notice. Copyright by KOBELCO CONSTRUCTION MACHINERY CO., LTD. No part of this catalog may be reproduced in any manner without notice.

KOBELCO CONSTRUCTION MACHINERY CO., LTD.

5-15, Kitashinagawa 5-chome, Shinagawa-ku, Tokyo 141-8626 JAPAN
 Tel: +81 (0) 3-5789-2146 Fax: +81 (0) 3-5789-2135
<https://www.kobelcocm-global.com/>

Inquiries To:



Power Meets Efficiency

Increase in
productivity
means
"Power"

17%*
Higher fuel
saving means
"Efficiency"

In line with KOBELCO's concept of earth-friendly construction machinery that will work long and hard on any site on the planet, the rugged machine body is newly designed, and comprehensive reinforcement makes the attachment more robust.

It all adds up to KOBELCO's toughest ever mining excavator.

The latest hydraulics technology delivers both high-powered output and lower fuel consumption.

As the 10th generation model of KOBELCO's SK series, the SK500XD SK500XDLC SK520XDLC meets the needs of the most punishing mining sites with a performance that simply astounds.



*Compared to H-mode on the SK480LC-8

Even stronger attachment

Increase in productivity means "Power"

The boom and arm that take the greatest punishment are significantly reinforced.

Newly developed boom made of thicker steel plate

The XD boom features reinforcement plates, which increases longevity even under the toughest working conditions.

XD boom **NEW**

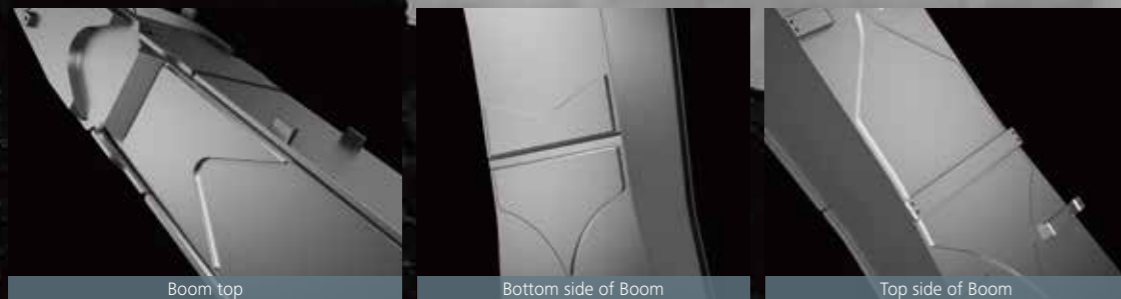

Boom top

Bottom side of Boom

Top side of Boom

ME boom **NEW**

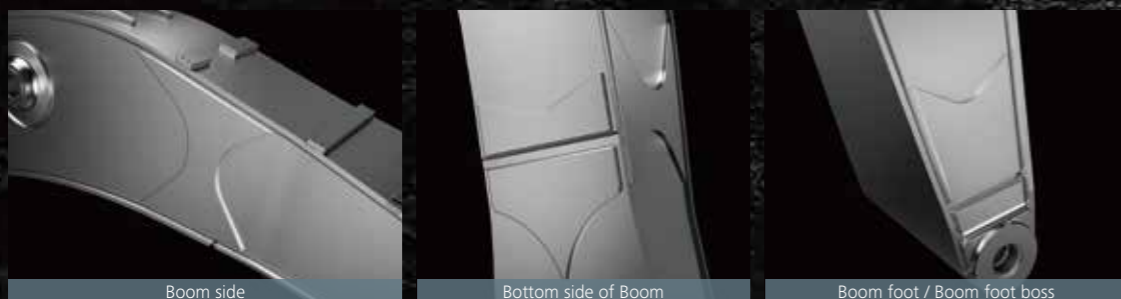

Boom side

Bottom side of Boom

Boom foot / Boom foot boss



Rock Guards

Specially designed long, solid rock guard installed to prevent damage to arm.



Reinforced 2.1m³ bucket for heavy duty

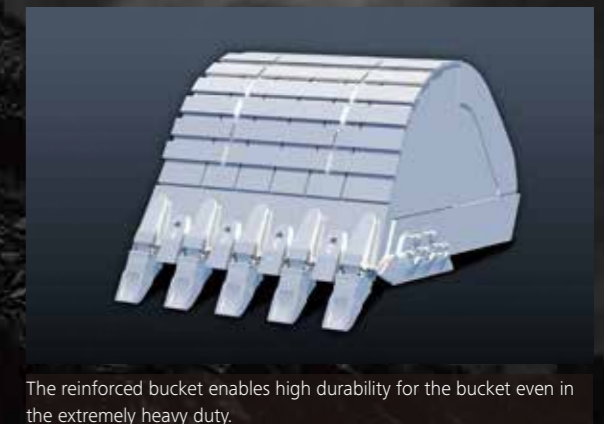

The reinforced bucket enables high durability for the bucket even in the extremely heavy duty.

Reinforced arm exhibits strength

Thickness of steel plate for arm top and arm foot has been increased to deliver more strength for toughest working conditions.

XD arm **NEW**



Arm top

Arm foot

ME arm **NEW**



Arm top

Arm foot

Upper Under Covers

Thick covers with increased durability compared to standard models.



Increase in productivity means "Power"

Powerful travel system for easy transit over loose stones, and highly reliable filtration system ensure higher machine performance.



Crawlers Built for Unbeatable Durability

Reinforced Guide Frame



Reinforced guide frame prevents deformation caused by impact or encroaching of loose stones.

Track Guides



Large, reinforced track guides are installed in two locations.

Thicker steel plate for shoes



Reinforced HD shoes of thick steel plate to master rough, stony ground.

Track Links



The durability of the track link is increased compared to standard models.

Lower Under Cover



Hydraulic piping and equipment protected against damage from rubble and stony ground.

Built to operate in tough working environment

Hydraulic Drive for Engine Cooling Fan; Independent Oil Cooler Fan NEW



Hydraulic drive optimizes the cooling fan rotation speed to improve fuel economy and reduce noise. Also, the independent oil cooler fan better matches cooling to the hydraulic oil temperature, for optimal oil temperature control.

Improved Filtration System Reliability

Clean, contaminant-free fuel and hydraulic fluid are essential to stable performance. The improved filtration systems reduce the risk of mechanical trouble and enhance longevity and durability.

Fuel Filter NEW

The pre-filter, with built-in water separator maximizes filtering performance.

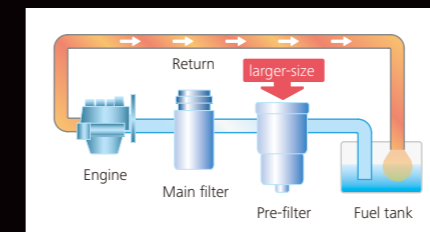

Hydraulic Fluid Filter NEW

Recognized as the best in the industry, our Premium-fine filter separates out even the smallest particles. New cover prevents contamination when changing filters.



Metal Mesh Cover Air Cleaner NEW

Metal mesh cover ensures strength and durability.



Enlarged filter image

Hydraulic Fluid Filter Clog Detector NEW

Hydraulic tank pressure sensor monitors the pressure difference between the return line and tank inside pressure to determine the degree of clogging. If the difference exceeds a predetermined level, a warning appears on the multi-display, so any contamination can be trapped by the filter and replaced before it reaches the hydraulic fluid in the tank.

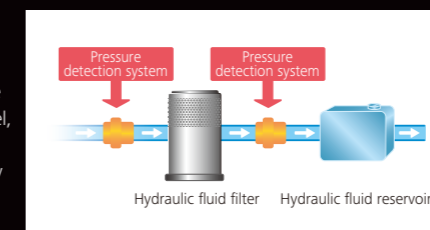

Evolution Continues, with Improved Fuel Efficiency.

17%*
Higher fuel saving means
"Efficiency"

The new arm interflow system more efficiently controls hydraulic fluid flow, and significant reduction of in-line resistance and pressure loss boosts fuel efficiency by about 17%*.

* Compared to H-mode on the SK480LC-8



Get More Done Faster with Superior Operability

ME 2.6 m arm

■ Max. Bucket Digging Force	■ Max digging reach:
Normal: 282kN	11,250mm
With power boost: 308kN	■ Max digging depth:
	6,820mm
■ Max. Arm Digging Force	■ Max vertical digging depth:
Normal: 239kN	6,110mm
With power boost: 261kN	

Short 3.0 m arm

■ Max. Bucket Digging Force	■ Max digging reach:
Normal: 270kN	11,770mm
With power boost: 295kN	■ Max digging depth:
	7,360mm
■ Max. Arm Digging Force	■ Max vertical digging depth:
Normal: 224kN	6,670mm
With power boost: 245kN	

Equipped with a 3.4m³⁺² ME bucket, the maximum digging reach stretches 370mm farther than the SK480LC-8, resulting in a reach of over 11m. **NEW**

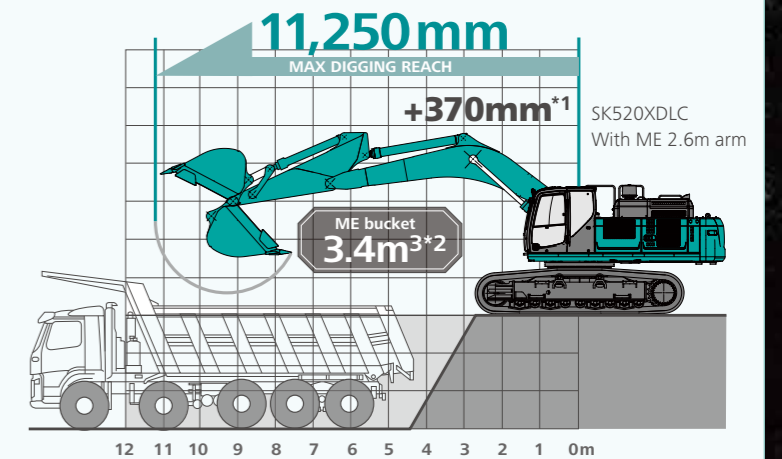

*1 Compared to SK480LC-8.
*2 To minimize spillage, 3.1m³ bucket may be better suited to width of some dump trucks.

Hydraulic System: Revolutionary Technology Saves Fuel

Arm Interflow System **NEW**

When lowering the boom, this system uses the downward force generated by the boom's weight to push fluid to the shovel arm. This greatly reduces the need to apply power from outside the system.

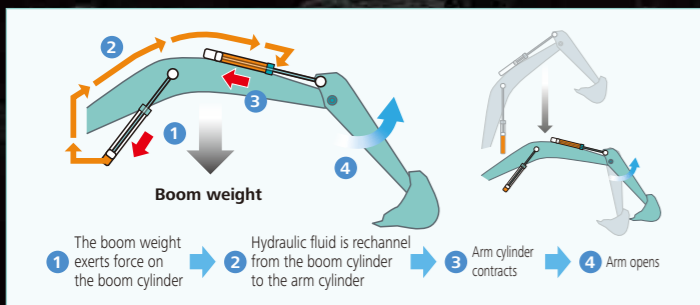

Energy saving system saves fuel further

Fuel efficient work mode ECO mode **NEW**

The fuel-saving ECO mode is newly provided to the work mode, selectable according to a desired operation. Fuel consumption can be greatly reduced.

- E** Used to reduce fuel consumption for small workloads
ECO-mode, 26% decrease
(compared to S-mode on the SK480LC-8)
- H** Used to prioritize the amount of work done
H mode, 17% decrease
(compared to H-mode on the SK480LC-8)
- S** Used to strike a balance between workloads and fuel efficiency
S mode, 16% decrease
(compared to S-mode on the SK480LC-8)

Top Class Traveling Force

Powerful traveling force and drawbar pulling force deliver plenty of speed when climbing slopes or negotiating bad roads, and the agility to change direction swiftly and smoothly.

■ Drawbar Pulling Force: **415kN**

Comfortable Cab Is Now Safer than Ever.

A work environment that is quieter and more comfortable. A cab that puts the operator first is key to improved safety.



Large cab ^{NEW}

4 % larger than the previous cab capacity. Relaxing environment allows work to be performed in comfort.

Air Conditioner ^{NEW} Louvers behind the Seat



The large air-conditioner has louvers on the back pillars that blow from behind and to the right and left of the operator's seat. They can be adjusted to put a direct flow of cool/warm air on the operator, which means a more comfortable operating environment.

Super-Airtight Cab ^{NEW}



The high level of air-tightness keeps dust out of the cab.

Low Vibration ^{NEW}

Coil springs absorb small vibrations, and high suspension mounts filled with silicone oil reduce heavy vibration. The long stroke achieved by this system provides excellent protection from vibration.

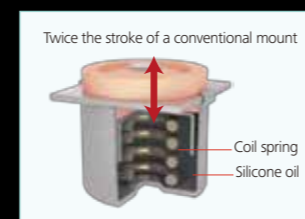

Multi-Display in Color ^{NEW}

Brilliant colors and graphic displays are easy to recognize on the LCD multi-display in the console. The display shows fuel consumption, maintenance intervals, and more.



- 1 Analog gauge provides an intuitive reading of fuel level and engine water temperature
- 2 Green indicator light shows low fuel consumption during operation
- 3 Fuel consumption/Switch indicator for rear camera images
- 4 Digging mode switch
- 5 Monitor display switch

One-Touch Attachment Mode Switch

A simple touch of a button, switches the hydraulic circuit and flow amount to match attachment changes. Icons help the operator to confirm the proper configuration at a glance.

Comfort



Broad View ^{NEW} Liberates the Operator

The front window features one large piece of glass without a center pillar on the right side for a wide, unobstructed view.

Large Cab Is Easy ^{NEW} to Get in and Out of

The expanded cab provides plenty of room for a large door, more headroom and smoother entry and exit.



More Comfortable Seat Means Higher Productivity

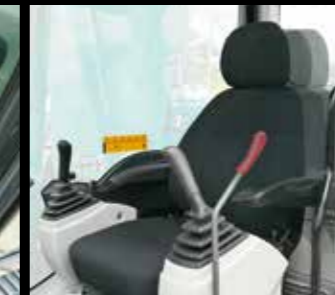

A Light Touch on the ^{NEW} Lever Means Smoother, Less Tiring Work



It takes 38% less effort to work the operation lever, which reduces fatigue over long working hours or continued operations.

Interior Equipment Adds to Comfort and Convenience



Safety

ROPS Cab ^{NEW} (optional)



ROPS (Roll-Over-Protective Structure)-compliant cab clears ISO standards (ISO-12117-2: 2008) and ensures greater safety for the operator should the machine tip over.

Wide view during operations High Visibility for Safety



Greater safety assured by rearview mirrors on left and right.

Rear view camera ^{NEW} (optional)



A rear view camera is installed as option to simplify checking for safety behind the machine. The picture appears on the color monitor.



Efficient Maintenance Keeps the Machine in Peak Operating Condition.



Examples of displaying maintenance information

Machine Information Display Function

- Displays only the maintenance information that's needed, when it's needed
- Self-diagnostic function provides early-warning detection and display of electrical system malfunctions
- Service-diagnostic function makes it easier to check the status of the machine
- Record function of previous breakdowns including irregular and transient malfunction

Easy, On-the-Spot Maintenance

There is ample space in the engine compartment for a mechanic to do maintenance work inside. The distance between steps is lower so entry and exit is easier. And the mechanic can work in comfort, without contortions or unnatural body positions. Finally, the hood is lighter and easier to raise and lower.

Maintenance Work, Daily Checks, Etc., Can Be Done from Ground Level

The layout allows for easy access from the ground for many daily checks and regular maintenance tasks.



Step/Hand rail



Fuel filter with built-in water separator/Fuel filter



Left side

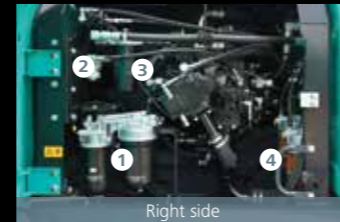

Right side

Simple layout for easy access to radiator and cooling system elements.

- 1 Engine oil filter
- 2 Pilot filter
- 3 Pump drain filter
- 4 Fuel filter with built-in water separator

Easy Cleaning

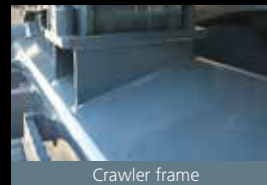

Crawler frame



Detachable two-piece floor mat



Floor mat with raised edges



Engine oil pan



Double-element air cleaner

Special crawler frame design for easy mud removal cleaning.

Detachable two-piece floor mat with handles for easy removal. A floor drain is located under floor mat.

Floor mat's raised edges help keep the cab floor free of mud, simplify cleaning.

Engine oil pan equipped with drain valve.

More Efficient Maintenance Inside the Cab

Internal and external air conditioner filters can be easily removed without tools for cleaning.



Air conditioner filters

KOMEXS (Kobelco Monitoring Excavator System)

KOMEXS is the remote monitoring system for SK series excavators. When a hydraulic excavator is fitted with this system, data on the machine's operation, such as operating hours, location, fuel consumption, and maintenance status can be obtained remotely.



Specifications

SK500XD
SK500XD-10

SK500XD LC
SK500XDLC-10

SK520XD LC
SK520XDLC-10

Engine

Model	HINO P11C
Type	Water-cooled, 4cycle 6cylinder direct injection type diesel engine with intercooler turbo-charger
No. of cylinders	6
Bore and stroke	122 mm × 150 mm
Displacement	10.52 L
Rated power output	Net 257 kW/1,850 min ⁻¹ (ISO 14396 : without fan)
Max. torque	Net 1,400 N·m/1,400 min ⁻¹ (ISO 14396 : without fan)

Hydraulic System

Pump	
Type	Two variable displacement pumps + One gear pump
Max. discharge flow	2 × 370 L/min
Relief valve setting	
Excavating circuits (main)	31.4 Mpa
Power boost	34.3 Mpa
Travel circuit	34.3 Mpa
Swing circuit	26.0 Mpa
Pilot control circuit	5.0 Mpa
Pilot control pump	Gear type
Main control valve	8-spool
Oil cooler	Air cooled type

Swing System

Swing motor	Axial piston motor
Parking brake	Wet multiple plate, hydraulic operated automatically
Swing speed	7.6 min ⁻¹
Swing torque	183 kN·m

Attachments

Backhoe bucket and combination

Use	Backhoe bucket					
	Heavy digging	Normal digging	Mass Excavating			
Bucket capacity	ISO heaped	m ³	2.1	1.9	3.1	3.4
Struck		m ³	1.5	1.5	2.2	2.45
Opening width	With side cutters	mm	1,660	1,750	1,850	1,990
	Without side cutters	mm	1,580	1,630	1,760	1,900
No. of teeth			5	5	5	6
Bucket weight		kg	2,270	1,560	2,280	2,410
Combination	3.0m short arm		○	○	—	—
	3.45m standard arm		○	○	—	—
	6.5m ME boom and 2.6 ME arm		—	—	○	○

◎ Standard ○ Recommend — Not applicable

Travel System

Travel motors	Variable displacement piston pump	
Travel brakes	Hydraulic	
Parking brakes	Wet multiple plate	
Travel shoes	SK500XD	47 each side
	SK500XDLC SK520XDLC	50 each side
Travel speed (high/low)	5.4/3.4 km/h	
Drawbar pulling force	415 kN	
Gradeability	70 % (35 deg)	

Cab & Control

Cab	
All-weather, sound-suppressed steel cab mounted on the high suspension mounts filled with silicone oil and equipped with a heavy, insulated floor mat.	
Control	
Two hand levers or two foot pedals for forward and backward operations of each track independently.	

Boom, Arm & Bucket

Boom cylinders	170 mm × 1,590 mm	
Arm cylinder	190 mm × 1,970 mm	
Bucket cylinder	SHD	160 mm × 1,410 mm
	ME	170 mm × 1,429 mm

Refilling Capacities & Lubrications

Fuel tank	638 L
Cooling system	47.4 L
Engine oil	42.5 L
Travel reduction gear	2×15 L
Swing reduction gear	2×5 L
Hydraulic oil tank	371 L tank oil level
	631 L hydraulic system

Working Ranges

Unit: m

Boom	ME 6.5m*1		7.0 m	
	Arm	ME 2.6Arm*1	3.0Arm	3.45Arm
Range				
a- Max. digging reach		11.25	11.77	12.07
b- Max. digging reach at ground level		11.01	11.54	11.84
c- Max. digging depth		6.82	7.36	7.81
d- Max. digging height		11.15	11.16	10.94
e- Max. dumping clearance		7.18	7.72	7.58
f- Min. dumping clearance		3.07	3.23	2.78
g- Max. vertical wall digging depth		6.11	6.67	7.12
h- Min. swing radius		4.96	5.28	5.14
i- Horizontal digging stroke at ground level		3.87	5.21	6.10
j- Digging depth for 2.4 m (8') flat bottom		6.66	7.2	7.67
Bucket capacity ISO heaped m ³		3.4	2.1	1.9

Digging Force (ISO 6015)

Unit: kN

Arm length	ME 2.6Arm*1	3.0Arm	3.45Arm
Bucket digging force	282/308*2	270/295*2	267/292*2
Arm crowding force	239/261*2	224/245*2	203/222*2

*1 Not applicable for SK500XD.

*2 Power Boost engaged.

Dimensions

Unit: mm

Arm length	ME 2.6Arm*1	3.0Arm	3.45Arm
A Overall length	12,200	11,980	12,160
B Overall height (to top of boom)	4,330	3,800	3,610
C Overall width		3,550	
D Overall height (to top of cab)		3,320	
E Ground clearance of rear end*		1,260*2	
F Ground clearance*		510*2	
G Tail swing radius	SK500XD SK500XDLC	3,800	
G' Distance from center of swing to rear end	SK500XD SK500XDLC	3,800	
H Tumbler distance	SK500XD	4,060	
I Overall length of crawler	SK500XD	5,120	
J Track gauge	SK500XDLC SK520XDLC	5,460	
K Shoe width		800	
L Overall width of upperstructure		3,110	

*1 Not applicable for SK500XD.
*2 Without including height of shoe lug.

Operating Weight & Ground Pressure

In standard trim, with standard boom, 3.00 m arm, and 2.1 m³ ISO heaped bucket

Shaped		Triple grouser shoes (even height)	
Shoe width	mm	600	800
Overall width of crawler	mm	3,350	3,550
Ground pressure	SK500XD	kPa	85
	SK500XDLC SK520XDLC	kPa	66
Operating weight	SK500XD	kg	49,300
	SK500XDLC SK520XDLC	kg	49,900

In standard trim, with 6.5 m ME boom, 2.6 m ME arm, and 3.4 m³ ISO heaped bucket

Shaped		Triple grouser shoes (even height)	
Shoe width	mm	600	800
Overall width of crawler	mm	3,350	3,550
Ground pressure	kPa	90	69
Operating weight	kg	52,200	53,400

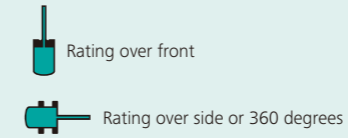
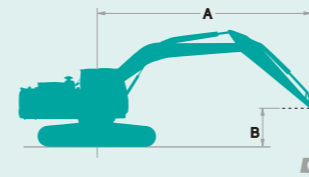
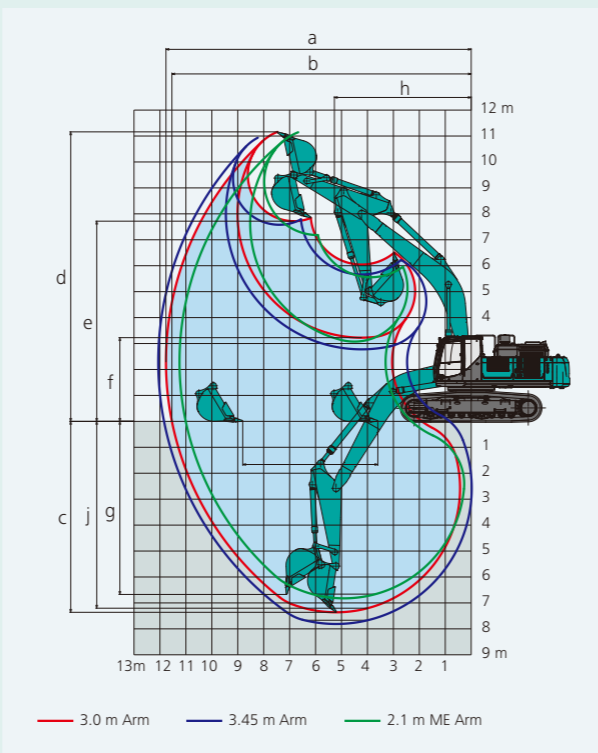

A: Reach from swing centerline to arm top
B: Arm top height above/below ground
C: Lifting capacities in Kilograms
Bucket: Without bucket
Relief valve setting: 34.3 MPa

SK500XD-10		Boom: 7.0 m Arm: 3.45 m Bucket: without Counterweight: 9,400 kg Shoe: HD 800 mm												
A	B	3.0 m		4.5 m		6.0 m		7.5 m		9.0 m		At Max. Reach		Radius
		9.0m	kg											
7.5m	kg													
6.0m	kg							*9,490	*9,490	*9,000	8,240	*8,940	7,360	9.59m
4.5m	kg			*16,130	*16,130	*12,320	*12,320	*10,450	*10,450	*9,430	8,020	*9,020	6,690	10.04m
3.0m	kg			*20,340	*20,340	*14,360	13,900	*11,560	10,120	*10,030	7,750	9,210	6,330	10.26m
1.5m	kg			*13,430	*13,430	*16,030	13,140	*12,580	9,680	*10,600	7,500	9,090	6,210	10.25m
G.L.	kg			*16,440	*16,440	*16,970	12,710	*13,260	9,370	10,800	7,320	9,310	6,340	10.01m
-1.5m	kg	*11,830	*11,830	*22,960	19,260	*17,110	12,550	*13,450	9,240	10,740	7,260	9,950	6,760	9.53m
-3.0m	kg	*20,240	*20,240	*21,500	19,480	*16,400	12,630	*12,910	9,290				*10,460	8.76m
-4.5m	kg	*25,000	*25,000	*18,790	*18,790	*14,500	12,930	*10,940	9,600				*10,600	9.410

SK500XD-10		Boom: 7.0 m Arm: 3.0 m Bucket: without Counterweight: 9,400 kg Shoe: HD 800 mm												
A	B	3.0 m		4.5 m		6.0 m		7.5 m		9.0 m		At Max. Reach		Radius
		9.0m	kg											
7.5m	kg							*9,540	*9,540				*9,650	8,980
6.0m	kg							*10,010	*10,010	*9,520	8,120		*9,560	7,680
4.5m	kg			*17,470	*17,470	*12,990	*12,990	*10,910	10,490	*9,830	7,930		*9,610	6,960
3.0m	kg					*14,930	13,640	*11,950	10,000	*10,340	7,690		9,590	6,580
1.5m	kg					*16,410	12,970	*12,860	9,590	*10,820	7,460		9,480	6,480
G.L.	kg			*12,370	*12,370	*17,100	12,620	*13,400	9,330	10,800	7,320		9,760	6,640
-1.5m	kg	*9,270	*9,270	*21,700	19,300	*16,980	12,540	*13,390	9,250	*10,790	7,330		*10,400	7,140
-3.0m	kg	*20,210	*20,210	*20,630	19,600	*15,970	12,690	*12,550	9,370				*10,530	8,160
-4.5m	kg	*22,360	*22,360	*17,460	*17,460	*13,560	13,090						*10,320	*10,320

SK500XDLC-10		Boom: 7.0 m Arm: 3.45 m Bucket: without Counterweight: 9,400 kg Shoe: HD 800 mm												
A	B	3.0 m		4.5 m		6.0 m		7.5 m		9.0 m		At Max. Reach		Radius
		9.0m	kg											
7.5m	kg													
6.0m	kg							*9,490	*9,490	*9,000	8,360		*8,940	7,460
4.5m	kg			*16,130	*16,130	*12,320	*12,320	*10,450	*10,450	*9,430	8,140		*9,020	6,780
3.0m	kg			*20,340	*20,340	*14,360	14,080	*11,560	10,260	*10,030	7,860		*9,280	6,420
1.5m	kg			*13,430	*13,430	*16,030	13,330	*12,580	9,820	*10,600	7,610		*9,530	6,310
G.L.	kg			*16,440	*16,440	*16,970	12,890	*13,260	9,510	*10,980	7,430		*9,830	6,440
-1.5m	kg	*11,830	*11,830	*22,960	19,530	*17,110	12,740	*13,450	9,380	*10,950	7,370		*10,150	6,860
-3.0m	kg	*20,240	*20,240	*21,500	19,760	*16,400	12,810	*12,910	9,430				*10,460	7,740
-4.5m	kg	*25,000	*25,000	*18,790	*18,790	*14,500	13,120	*10,940	9,740				*10,600	9,550

SK500XDLC-10		Boom: 7.0 m Arm: 3.0 m Bucket: without Counterweight: 9,400 kg Shoe: HD 800 mm												
A	B	3.0 m		4.5 m		6.0 m		7.5 m		9.0 m		At Max. Reach		Radius
		9.0m	kg											
7.5m	kg							*9,540	*9,540				*9,650	9,100
6.0m	kg							*10,010	*10,010	*9,520	8,230		*9,560	7,790
4.5m	kg			*17,470	*17,470	*12,990	*12,990	*10,910	10,630	*9,830	8,050		*9,610	7,060
3.0m	kg					*14,930	13,830	*11,950	10,140	*10,340	7,800		*9,750	6,680
1.5m	kg					*16,410	13,150	*12,860	9,730	*10,820	7,570		*9,950	6,580
G.L.	kg			*12,370	*12,370	*17,100	12,810	*13,400	9,470	*11,080	7,430		*10,180	6,740
-1.5m	kg	*9,270	*9,270	*21,700	19,580	*16,980	12,730	*13,390	9,390	*10,790	7,440		*10,400	7,250
-3.0m	kg	*20,210	*20,210	*20,630	19,870	*15,970	12,870	*12,550	9,510				*10,530	8,280
-4.5m	kg	*22,360	*22,360	*17,460	*17,460	*13,560	13,280						*10,320	*10,320